

HKE_x Information Services Limited (“HKE_x-IS”)
(A wholly-owned member of Hong Kong Exchanges and Clearing Limited Group)

DERIVATIVES MARKET DATA

**PRICE REPORTING SYSTEM (PRS)
TRANSMISSION SPECIFICATION**

VERSION : 3.2.11
ISSUE DATE : 22 May 2013

Amendment History

Version	Date	Remarks
3.0	14 Nov 2008	<p>PRS Enhancement 2008/2009</p> <ul style="list-style-type: none"> Message restructuring and introduction of new PRS message types. <p><u>Highlights of Major Enhancement:</u></p> <ol style="list-style-type: none"> Section 2.2, remove SYN characters in message Section 2.3, remove Block Check Character (BCC) Section 3.1.3, revise dissemination time of morning quotation image messages at 07:45 for all markets Section 3.1.4, messages during trading hour Section 4, replace message sequence number field by a real-time message indicator Section 4, relocate decimal place field in PRS messages (Section 4.1 to 4.3, 4.6 and 4.7) from group Series ID to Content. Section 4.1, enhance Trade message field and length Section 4.2, introduce new message type for Trade statistic Section 4.3, introduce “Net OI” in Summary Statistics message Section 4.4, reorganize Control message fields and length Section 4.5, reorganize Underlying message fields and length Section 4.8, introduce new message type for Series Definition Section 4.9, introduce new message type for Market/Commodity status Section 6, remove the broadcast time of summary statistic at noon. APPENDIX B: LIST OF INSTRUMENT CODE APPENDIX C: LIST OF DEAL TYPE APPENDIX D: LIST OF MARKET ID APPENDIX E: LIST OF STATUS CODE APPENDIX F: REMARKS ON TRADE MESSAGE APPENDIX G: RECOVERY OPTION OF SERIES DEFINITION MESSAGE
3.0a	27 Mar 2009	<ul style="list-style-type: none"> Section 3.1.3, revise the message dissemination time. Section 7.4, revise the message examples of DA, DN and DC.
3.0b	1 Apr 2009	<ul style="list-style-type: none"> Section 4.3, revise remarks Section 6.1, revise 2nd table.
3.0c	21 May 2009	<ul style="list-style-type: none"> Section 4.1, add remarks for trade cancellation Section 4.4, add remarks for freeform/alert message Section 4.6, revise remarks Section 4.8, rectify valid values of field Number of Reference Series and the DS examples Section 7.1, update location of PRS operating centres
3.1	16 Nov 2009	<ul style="list-style-type: none"> Introduction of Flexible Index Options in Q1 2010 Section 4, clarification of message contents Section 7.4, revise example Appendix A, add commodity codes XHS and XHH Appendix D, add market codes 35 and 37
3.2	14 May 2010	<ul style="list-style-type: none"> Section 4.8, introduce new message type of Next Day Series Definition Section 4.8, add new fields for Trading Status and Currency Section 2.8, 3.1.4, 3.1.5 & 5.1 revised for the new message type Appendix A, revise table

PRICE REPORTING SYSTEM
TRANSMISSION SPECIFICATION

Version	Date	Remarks
3.2.1	14 Sep 2010	<ul style="list-style-type: none"> • Introduction of HSI Dividend Point Index Futures (DHS) and HSCEI Dividend Point Index Futures (DHH) on 1 November 2010 • Section 4.4, clarify field attribute • Appendix G, revised for the group of Series Definition messages
3.2.2	20 Dec 2010	<ul style="list-style-type: none"> • Update description in Section 3.1.2, Section 3.6 • Update for SDNet line bandwidth from 2Mbps to 3-4Mbps
3.2.3	18 Feb 2011	<ul style="list-style-type: none"> • Appendix B, add instrument code 172 for Standard Combination series for Stock Options Market (SOM) – Synthetic Futures
3.2.4	3 June 2011	<ul style="list-style-type: none"> • Revise Section 4.1 – 4.3 and Appendix C & F for price dissemination of combination trade
3.2.5	16 Dec 2011	<ul style="list-style-type: none"> • Revise Section 3.1 and Appendix A & D, add HSI Volatility Index Futures product
3.2.6	17 Jan 2012	<ul style="list-style-type: none"> • Introduction of Bovespa Index Futures in Q1 2012 • Introduction of MICEX Index Futures in Q1 2012 • Introduction of SENSEX Index Futures in Q1 2012 • Introduction of FTSE/JSE Top 40 Index Futures in Q1 2012 • Appendix A, add commodity codes BOV, MCX, BSE and SAF • Appendix D, add market codes 93, 96, 99 and 102
3.2.7	12 Mar 2012	<ul style="list-style-type: none"> • Termination of price feed without depth • After-Hour Future Trading arrangement in 2nd half of 2012
3.2.8	6 July 2012	<ul style="list-style-type: none"> • Appendix E, add status code 19
3.2.9	22 Aug 2012	<ul style="list-style-type: none"> • Introduction of renminbi (RMB) currency futures on 17 September
3.2.10	14 Feb 2013	<ul style="list-style-type: none"> • Section 3.2. After-Hour Future Trading arrangement update
3.2.11	22 May 2013	<ul style="list-style-type: none"> • Introduction of CESC 120 futures on July • Update on Section 6.1 Summary Statistics Broadcasting Time

Table of Contents

1	INTRODUCTION	5
1.1	Purpose	5
1.2	Reading Guide	5
2	MESSAGE SYNTAX CONTROL	6
2.1	Line Protocol	6
2.2	Message Header	6
2.3	Message Details	6
2.4	Message Trailer	6
2.5	Character Codes	6
2.6	Record	6
2.7	Message Mix	6
2.8	Message Types	6
3	COMMUNICATION & RECOVERY	7
3.1	System Overview	7
3.1.1	System Sites	7
3.1.2	Scope of Information	7
3.2	Data Transmission	8
3.2.1	Start of Day Transmission	8
3.2.2	Regular Hour Trading Transmission (T Session)	9
3.2.3	After Hour Trading Transmission (T+1 Session)	9
3.2.4	End of day Transmission	9
3.2.5	Scheduled Holiday	10
3.2.6	Typhoon and Black Rainstorm Arrangement	10
3.3	Connection Packages & Method	11
3.4	Line Connection Failure	15
3.5	Primary Trading System Failure	15
3.6	Connection failure detection and recovery mechanism	16
3.7	Technical Requirement for Direct Connection Vendors	16
4	MESSAGE FORMATS	17
4.1	Trade Detail Message	18
4.2	Trade Statistic Message	19
4.3	Summary Statistics Message	20
4.4	Control/Freeform/Alert Message	22
4.5	Underlying Instrument Message	23
4.6	Price Depth Quotation Message (5 levels)	24
4.7	Series Definition Message	25
4.8	Market/Commodity Status Message	27
4.9	Heartbeat Message	28
5	DATA FIELD CHARACTERISTICS	29
5.1	Message Category/Code	29
5.2	Real-time Indicator	29
5.3	Time Stamp	29
5.4	Snapshot Image for Recovery	30
6	MARKET MESSAGE SCHEDULE	31
6.1	Summary Statistics Broadcasting Time	31
7	MARKET DATA RETRANSMISSION	32
7.1	Data Retransmission Function	32
7.2	Data Recovery Period	34
7.3	Supported Message Type	34
7.4	Making a Download Request	34
7.5	Retransmission Limitation	36
	APPENDIX A: LIST OF COMMODITY CODE	37
	APPENDIX B: LIST OF INSTRUMENT CODE	39
	APPENDIX C: LIST OF DEAL TYPE	40
	APPENDIX D: LIST OF MARKET ID	41
	APPENDIX E: LIST OF STATUS CODE	42
	APPENDIX F: REMARKS ON TRADE MESSAGE	43
	APPENDIX G: RECOVERY OPTION OF SERIES DEFINITION MESSAGE	45

1 INTRODUCTION

1.1 Purpose

This document describes the data transmission between Price Reporting System (PRS) and Information Vendors. It defines the real-time market data provided by the Price Reporting System and the message records that contain the data. Also it suggests the error handling and recovery procedures for Information Vendors to recover from connection interruption.

The intended reader of this document is the technical personnel of the Information Vendors. This specification provides adequate information for Information Vendors to develop their own systems for receiving real time market data from the Price Reporting System.

1.2 Reading Guide

This document has been arranged so that a reader can easily find the information required.

The chapters following this introduction are:

- Chapter 2 : Message syntax
- Chapter 3 : Communication & recovery
- Chapter 4 : Message formats
- Chapter 5 : Field definition and snapshot for recovery
- Chapter 6 : Message broadcast schedule
- Chapter 7 : Market data retransmission function

2 MESSAGE SYNTAX CONTROL

Control of the message syntax is accomplished by the following definitions:-

2.1 Line Protocol

Messages are transmitted in blocks and the size of the record varies. Each message is transmitted with a message header and a message trailer. The layout of a message is shown below:-



Fig. 1 Message Format

2.2 Message Header

Each message starts with a SOH character (see Fig. 1).

2.3 Message Details

This part of a message may carry various message contents, which may include PRS series ID, trade details, price quotation, market information and etc. Please refer to Section 4 in this document for details.

2.4 Message Trailer

Each message ends with ETX, carriage return and line feed characters.

2.5 Character Codes

All characters in the message body are transmitted in ASCII, except Start-of Header (SOH), Start-of-String (STX) and End-of-String (ETX) which are Hex codes. Each character is coded as eight-bit data with no parity.

2.6 Record

The record contains the message being transmitted. It can be a trade message, a quotation message, a summary statistics message, a control/freeform/alert message, an underlying instrument message, a series definition message, a market/commodity status message or a heartbeat message.

2.7 Message Mix

Different types of messages are disseminated on real time basis to reflect the prevailing market conditions as timely and accurately as possible and without undue delay. It is the responsibility of the Information Vendor to separate, identify, process and store the different kinds of messages based on the message header field group.

2.8 Message Types

There are ten types of broadcast messages: -

1. Trade detail message
2. Trade statistic message
3. Summary statistics message
4. Control/Freeform/Alert message
5. Underlying instrument message
6. Quotation message
7. Calculated Opening Price message
8. Series definition message
9. Market/Commodity status message
10. Heartbeat message

Each type of message has also subdivided into categories. For detail of usage, please refer to the message definition in Section 4.

3 COMMUNICATION & RECOVERY

3.1 System Overview

3.1.1 System Sites

Price Reporting System is running on two sites for resilience. Both PRS on primary and backup sites disseminate information in real time. Information Vendors are suggested to design with system auto fail-over function, which enable them to switch their connections to alternate PRS site wherever an interruption is occurred.

3.1.2 Scope of Information

Price Reporting System provides real-time Derivatives trading information to Information Vendors. There are multiple markets/products in the Derivatives Market. For the latest information on the list of Derivatives products, please refer to the “Derivatives Market” under the “Trading Information” section on the HKEx website (www.hkex.com.hk).

Derivatives Products

Derivatives Market Data for PRS	Derivatives Products covered	Product Names
HKFE Data:	1. Interest Rate, Fixed Income and Precious Metal Products	<ul style="list-style-type: none"> ▪ HIBOR Futures/Strips ▪ 3-Year Exchange Fund Notes Futures ▪ Gold Futures ▪ Renminbi (RMB) currency Futures
	2. Equity Index Products	<ul style="list-style-type: none"> ▪ Hang Seng Index Futures & Options ▪ Mini-Hang Seng Index Futures & Options ▪ H-shares Index Futures & Options ▪ Mini H-shares Index Futures ▪ Flexible Hang Seng Index Options ▪ Flexible H-shares Index Options ▪ HSI Dividend Point Index Futures ▪ HSCEI Dividend Point Index Futures ▪ HSI Volatility Index Futures ▪ BRISC BOVESPA Index Futures ▪ SENSEX Index Futures ▪ BRICS FTSE/JSE TOP 40 Index Futures ▪ BRICS MICEX Index Futures ▪ CESC 120 Index Futures
	3. Equity Products	
	3.1 Stock Futures	<ul style="list-style-type: none"> ▪ Stock Futures
Stock Options	3.2 Stock Options	<ul style="list-style-type: none"> ▪ Stock Options on HKEx Securities market instruments

Information Provided

- Definition information: market id, decimal place, last trading date, series name, reference baits series
- Real-time trading information: open/high/low, traded price ; Calculated Opening Price COP (for derivatives products with pre-market opening period only); trade volume, cumulative volume, block trade volume and deal type.
- Underlying Instrument (if available, please refer to Section 4.5 for availability information): Estimated Average Settlement (EAS) price, high/low
- Market Status: trading status of individual market, instrument or commodity
- Summary Statistics: opening buy/sell quote, opening trade price, closing buy/sell quote, settlement price, gross open interest, net open interest
- Aggregated volume and bid/ask prices for the best five orders

Note:

HSI, HHI, DHS, DHH and VHS are Third Party Content and are compiled and maintained by [Hang Seng Indexes Company Limited](#). The Exchange disseminates this information on an "as is" basis without any liability for any loss or damage arising from any inaccuracies or omissions.

3.2 Data Transmission

PRS supports Regular Hour Trading (T) and After-Hour Trading (T+1) Sessions. The following diagram illustrates the PRS message types to be disseminated during different time intervals on a normal trading day of a derivatives product tradable in T+1 session after the introduction of After Hour Trading (launch date to be confirmed). Please refer to Section 4 for the details of PRS message types (e.g. "DS"), Appendix E for the code and description of each market status (e.g. CL_START), and the HKEx website for the latest list of derivatives products tradable in the T+1 Session and their respective trading time tables.

PRS messages disseminated during time intervals of a normal trading day for markets with AHFT Session

HSI & HHI Futures

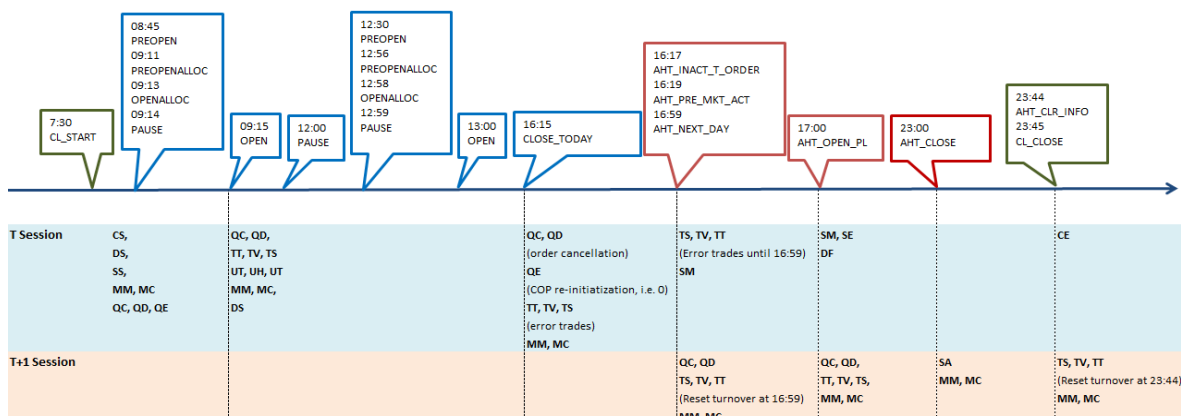

3.2.1 Start of Day Transmission

Price Reporting System is ready for connection at 07:00 am on every business day.

At around 07:15 am, a Control Message ("CS") is broadcasted indicating the start-of-day for a new business day. Series Definition Messages ("DS") are also disseminated for all series available for trading in the T Session on HKATS on that day. For a derivatives product tradable in the T+1 Session, its tradable series in the T+1 Session are the same as the T Session, except those series with the last trading day same as the current day. Note that PRS may disseminate "DS" whenever there is new tradable series introduced or a series is suspended / resumed for trading during the day.

Summary statistics of all non-combo series with the latest Open Interest (Gross & Net OI) and Settlement Price are broadcasted at around 07:30am by transmitting Summary Statistics Messages (“SS”). The Open Interest figure includes the updated position as incurred during the T+1 Session on previous business day. After the dissemination of Summary Statistic Messages, the Market Status Messages (“MM”/“MC”) will follow to reflect the latest status of all markets. In fact, Market Status Messages may be transmitted at any time during the day to update the status of a Market or a Commodity when there is a change.

At around 7:45, before market open, Quotation Messages (“QC/QD”) of all series are disseminated for the updates of outstanding order position in markets. Information Vendors should update the quotation position of all series according to the latest broadcast.

3.2.2 Regular Hour Trading Transmission (T Session)

Real time Trade Detail Messages (“TT/TV”), Trade Statistics Message (“TS”), Quotation Messages (“QC/QD”) will be sent upon Exchange Participant’s activities on the series. Underlying Messages (“UT”/“UH”/“UL”) will be sent upon updates of underlying information. Series Definition Messages (“DS”) will be sent if a new series is created in HKATS or a series is suspended / resumed during the trading hours.

After the close of the T Session, Quotation Messages (“QC/QD”) will be sent upon changes in price queue due to order cancellation. Trade Details Messages (“TT/TV”) and Trade Statistics Message (“TS”) will be sent upon correction of error trades. Market Close Summary Statistics Messages (“SM”) carrying the price and turnover statistics information of individual series for the T Session are disseminated as soon as the settlement price is determined. Please refer to Section 6 in this document for the transmission schedule.

Summary statistics of all series with current day Open Interest (OI) and Settlement Price are broadcasted at around 21:30. Summary Statistics Message (“SE”) carries the said figures for the T Session.

3.2.3 After Hour Trading Transmission (T+1 Session)

Market Status Messages (“MM/MC”) are sent between the T and T+1 Sessions to reflect the changes of market status to proceed to the T+1 Session.

For those derivatives products tradable in the T+1 Session, Trade Details Messages (“TT/TV”) and Trade Statistic Messages (“TS”) are sent for resetting market figures just before the T+1 Session starts.

Real time Trade Detail Messages (“TT/TV”), Trade Statistics Message (“TS”), Quotation Messages (“QC/QD”) will be sent upon Exchange Participant’s activities on the series. Underlying Messages (“UT”/“UH”/“UL”) will be sent upon updates of underlying information.

After the close of the T+1 Session, End of After-Hour Session Summary Statistic Messages (“SA”) is disseminated for those products tradable in the T+1 Session to reflect their trading statistics on price and turnover during the T+1 Session.

3.2.4 End of day Transmission

Next Day Series Definition Messages (“DF”) is broadcasted at around 20:00. It carries the tradable series definition of futures and options for the next business day, except for combo series.

A “Control/Freeform/Alert Message” - End-of-day Message (“CE”) is sent after all market messages have been disseminated. PRS and Data Retransmission are scheduled to be shutdown at around 23:30 and 23:45 respectively. All Information Vendors’ connections would be terminated according to the corresponding shutdown time, unless special arrangement for shutdown is required. The same system shutdown time would also apply to half day trading days. After system shut down, PRS services (include Data Retransmission) would not be available for Information Vendors till the next Trading day

(i.e. 07:00). Information vendors (the Emergency Contact) would be notified by email in case of special arrangement or extension of PRS shutdown for the day being required.

3.2.5 Scheduled Holiday

PRS operates on every business day when there is at least one market open for trading. If it is a scheduled holiday and there is no Derivatives market open for trading, PRS will NOT be brought up at 07:00 for vendor connections.

For holiday schedule of the Derivatives market, information vendors should refer to the Derivatives Market Trading Calendar under the Trading Information section of the [HKEx](#) website.

3.2.6 Typhoon and Black Rainstorm Arrangement

PRS would normally be brought up on all trading days even if Typhoon Signal No. 8 (or above) is hoisted or Black Rainstorm warning is issued in Hong Kong. However, the availability of the trading information would be subject to the prevailing trading arrangement for the Derivatives Market during Typhoon or Black Rainstorm conditions.

Vendors can refer to the HKEx website for the standard [trading arrangement](#) for the Derivatives Market under different Typhoon and Black Rainstorm scenarios.

Vendors may also refer to the Trading News available on the HKEx website under the Securities Market area within Trading Information section for the latest Exchange News on the Typhoon/Black Rainstorm day.

3.3 *Connection Packages & Method*

3.3.1 LINE PROTOCOL

Mode of Transmission	:	IP-based Network
Communication Line Speed	:	5Mbps
Communication Protocol	:	TCP (100Mbps full duplex)

IP address on Client Side:

- One set of IP addresses is assigned to a client to access PRS
- HKEx will assign a set of dedicated IP addresses to each Information Vendor

IP address on Server side:

- Access to the Primary & Secondary server IP addresses is granted for the client side (with pre-assigned IP address) to connecting to an assigned port number.

3.3.2 CONNECTION REQUIREMENT

It is required that information vendors should **have at least two SDNet lines or an even number of lines** installed in their systems. Information Vendors should at all times ensure that all lines are ready so that in case of failure, the backup lines are ready to receive PRS data.

There are two connection models. The two lines should be arranged to establish either one pair of lines with **Hot Standby Router Protocol (HSRP)** or two single live lines.

Information vendor should have an internal procedure for detecting and handling leased line failure. Also, Information vendor should well define their internal site failover procedure for service recovery.

3.3.2.1 Standard Connection Model

[2 SDNet lines with 1 live connection and 1 back-up connection (Live-Backup)]

Under this model, an information vendor subscribes one pair of SDNet data lines which are configured with Hot Standby Router Protocol (HSRP) to support auto recovery of line failure.

Each of the two lines is connected to PRS production system either in the primary site (PRS Primary Server) or the backup site (PRS Secondary Server) and only one of them can receive live PRS data transmission Without resetting the IP address of PRS servers in vendor’s machine, the PRS secondary server should be used for backup purpose. Under the normal circumstance, information vendors should always connect to the PRS Primary Server.

One set (2 lines) of High Resilience 5Mbps circuits, running HSRP between the routers co-located in the same vendor site, are required. High resilience service on network connection is provided.

Network Diagram:

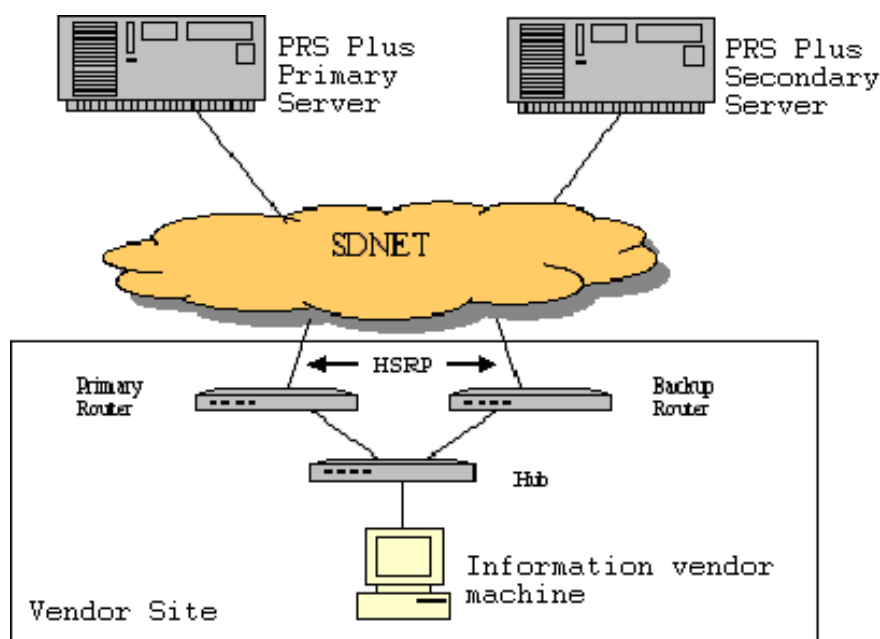

Diagram 1. Standard Connection Model
[2 SDNet lines with 1 live connection and 1 back-up connection (Live-Backup)]

Connection Details:

Connection – First Set of Connection	1
Number of SDNet line(s)	2
Number of SDNet router location(s) (i.e. vendor site)	1
Support auto line failover (i.e. HSRP)	Yes
Number of live connection(s)	1

Alternatively, information vendors can achieve even higher resilience by installing an additional pair of SDNet lines. Under this model, an information vendor will subscribe two sets of SDNet data lines which consists of four SDNet data lines in total. Each set of SDNet data lines is configured with HSRP to support auto recovery of line failure. Information vendor can receive real time live market data from the two independent communication channels. Hence, this configuration model provides the utmost uninterrupted service.

To further explain, under this enhanced connection model, an information vendor can establish one connection to the PRS Primary Server and another one to the PRS Secondary Server via the two independent sets of SDNet lines. PRS handshakes with the two communication channels separately and simultaneously.

Two pairs of SDNet lines with HSRP are required for this connection setup. Information vendors adopting this configuration **MUST** fulfil the obligation that each server in information vendor site(s) should establish only one live connection through individual leased line package either to the PRS Primary server at primary site or the Secondary server at backup site but not both at the same time. The primary and secondary servers of the information vendor for receiving PRS data feed concurrently through individual connection sets can be located at the same location or at different sites.

Network Diagram:

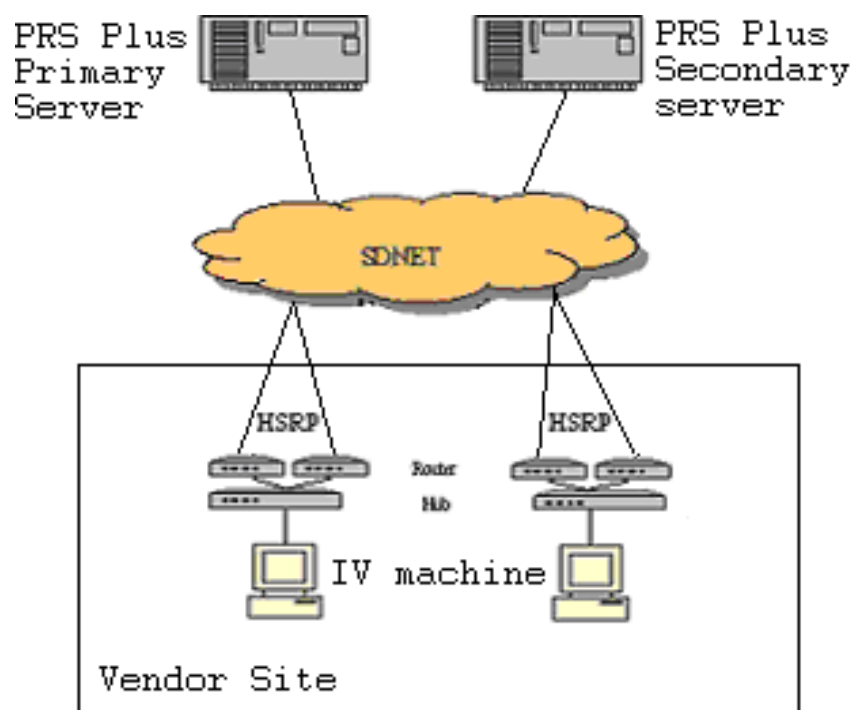

Diagram 2. Standard Connection with one additional set of connection Model
[4 SDNet lines with 2 live connections and 2 back-up connections (Live-Backup + Live-Backup)]

Connection Details:

Connection – First Set of Connection	1
Connection – Additional Set of Connection	1
Number of SDNet lines	4
Number of SDNet router location(s)* (i.e. vendor site)	1 – 2
Support auto line failover (ie. HSRP)	Yes
Number of live connection(s)	2

Note:

- * The pair of SDNet lines with HSRP must be co-located.

3.3.2.2 Two Live Connections without Backup Lines Model
[2 SDNet lines with 2 live connections (Live-Live)]

For information vendors who would like to receive real-time data via two live connections but want to install only one pair of lines, there is an option for them to give up the backup SDNet lines. Under this model, an information vendor subscribes one set of standard connection and one set of additional connection, both without backup SDNet lines (i.e. without HSRP). As a result, each network connection does not have resilient function when there is line failure and the information vendor will have to rely on the other live connection to continue the operation.

This connection configuration requires the vendor to establish connections to both the PRS Primary Server and the PRS Secondary Server, with one line connected to each of the PRS Primary and Secondary Servers. PRS operates the two communication channels separately and simultaneously.

The primary and backup servers of the information vendor for receiving PRS data feed concurrently through individual links can be located at the same location or at different sites.

Network Diagram:

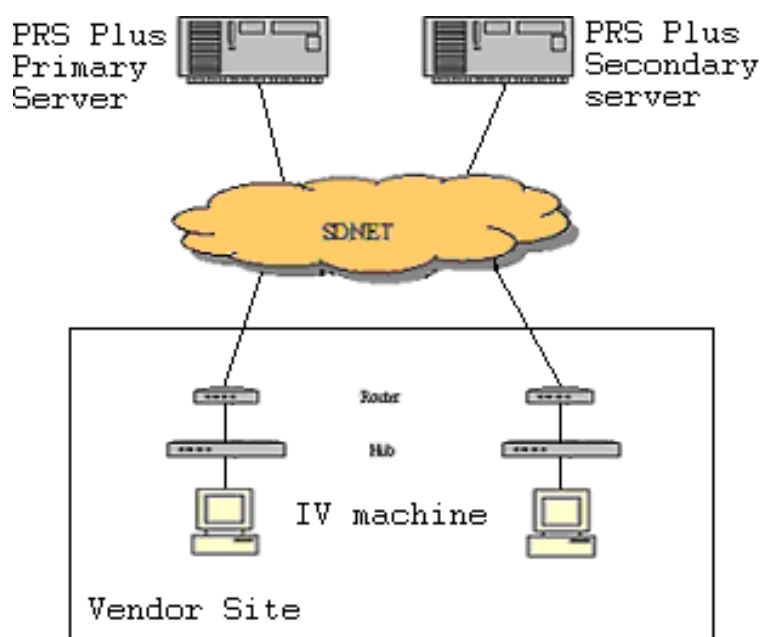

Diagram 3. Two Live Connections without Backup Lines Model
[2 SDNet lines with 2 live connections (Live-Live)]

Connection requirement:

Connection – First Set of Connection	1
Connection – Additional Set of Connection	1
Number of SDNet lines	2
Number of SDNet router location(s) (i.e. vendor site)	1 - 2
Support auto line failover (i.e. HSRP)	No
Number of live connection(s)	2

3.3.3 CONNECTION CONSTRAINT

Information vendors should always establish ONE connection to either the primary site or the backup site using either configuration.

For information vendor with dual live connections package, information vendor can establish two connections to PRS server. Both connections should not establish through the same 5Mbps SDNET network leased line. It is the obligation for information vendor to detect and fail over its system to its backup if the primary leased line connection is out of service.

Both PRS Primary and PRS Secondary servers have a limitation of 10 re-connection attempts daily. Information vendor should not disconnect and connect to the PRS servers over the limit. Data port will be closed temporary, and information vendor has to fill up an incident report before having the data port being re-activated.

Once a connection request is accepted, PRS sends messages through the connected socket immediately. It is the responsibility of information vendor to check the socket buffer for available records and clear the buffer when overloaded.

3.3.4 RECOVERY MECHANISM

PRS Primary and PRS Secondary Servers are disseminating real time data at the same time. Information vendor should design in a round robin fashion to hunt for PRS connection. A 5-second retry interval is suggested.

1. Primary PRS server
2. Secondary PRS server
3. Back to point #1

For vendors selected “Single Live Connection Model”, in all normal circumstance, vendor’s server should always connect to Primary PRS server. In case of failure on Primary PRS server, vendor’s program could failover to Secondary server for service recovery.

For vendors selected “Dual Live with High Resilience Connection Model” and “Dual Live without Resilience Connection Model”, in order to minimize the interruption of data service, vendor’s primary server should connect to Primary PRS server and vendor’s secondary service should connect to Secondary PRS server. In case of failure on Primary PRS server or Network levels, vendor’s program could failover to alternate server for service recovery. This arrangement can minimize data loss and interruption during recovery.

3.4 *Line Connection Failure*

Under any of the above configuration package, the IP address of PRS server is expected to be used for normal data transmission. For information vendor with dual live connections package, the IP address of PRS Secondary server is expected for backup server of information vendor to use as normal data transmission. Service interruption will be minimized. Whenever there is a connection failure, Information vendors should reconnect to PRS server by using the backup IP addresses mentioned in the previous pages.

3.5 *Primary Trading System Failure*

If a failure occurred in the primary trading system, trading system will failover to the backup site. The failover operation will take approximately 45 minutes. PRS system will connect to the trading system on the backup site to operate continuously. No trading data will be available during the failover period.

If site failover is occurred in the Exchange’s primary site, all systems will be discontinued in the primary site. Information vendors will be required to switch their connections to the backup site.

3.6 Connection failure detection and recovery mechanism

Information vendors may receive Heartbeat ('HB') message once application connected to PRS server. During communication idle time, PRS broadcasts 'HB' message in every 15 seconds. However, the 'HB' broadcast interval would be longer when PRS is busy disseminating large data volume. Information vendors are suggested to make use of the 'HB' message to determine the healthiness of their connections during idle time. If two or more consecutive 'HB' messages are missing (say > 30 seconds), information vendors should execute their own recovery plan immediately.

Once reconnected to PRS, information vendor application would receive all series definition followed by a snapshot of the current market information. The latest snapshot quotation and trade information would be sent together with real time messages.

By default, the definition message "DS" of all existing series will be sent prior to any snapshot and real time market information upon reconnection to PRS. However, information vendor can choose not to receive the "DS" messages when establishing the connection if the messages are not required. For the mechanism of this recovery option, please refer to APPENDIX G for details.

3.7 Technical Requirement for Direct Connection Vendors

Vendors who obtain derivatives market data directly from the HKEx must meet all the requirements as set out in this paragraph to ensure that their systems are capable of properly receiving our market data.

1. The system of direct connection vendors must meet all the requirements as set out in this PRS Transmission Specification.
2. Direct connection vendors should ensure that their systems have sufficient capacity to receive and process the Exchange's market data with minimum latency so as not to impair the timeliness of the data.
3. Direct connection vendors must ensure that lines connecting to the Exchange's PRS system meet the minimum bandwidth requirement as set out by the Exchange from time to time. (The minimum bandwidth requirement is at present 2.)
4. Direct connection vendors who are providing real-time feeds to indirect connection vendors must have dual live connections with the Exchange.
5. Direct connection vendors must be able to detect line failure automatically and reconnect within 1 minute. Such requirement will be included in the PRS Certification Test for new direct connection vendors and will be tested twice a year in the market rehearsals arranged by the Exchange. The results of the market rehearsals will be published on the HKEx website for public reference.
6. Direct connection vendors with retransmission service are advised to download the missing data from the period of disconnection rather than download full day record so as to avoid adverse effect on their services. Vendors with dual live connections should utilize the alternate connection to recover the missing data from the period of disconnection.
7. Applicants choosing direct connection with the PRS system must pass the PRS Certification Test according to the requirements as set out in the PRS Certification Test Procedures before they are approved to redistribute derivatives market data.
8. Other technical requirements mentioned in this transmission specification.

4 MESSAGE FORMATS

In general, a PRS message comprises 3 parts – Header, PRS Series ID and Message Contents. The followings are generally applied to PRS messages described in this Section:

Header (fixed length: 9 bytes)

- It is composed of the Message Category, Message Type, Real-time Indicator and Timestamp
- Please refer to Paragraph 5.1 for the complete list of Message Category and Message Type
- Real-time indicator shows “1” for real time message and “0” for snapshot message
- Timestamp is in HHMMSS format

PRS Series ID (fixed length: 19 bytes)

- It is composed of the Commodity Code, Instrument Code, Expiry Date and Strike Price
- Trailing blank is padded in the field of Commodity Code (Please refer to Appendix A)
- Leading zero is filled in the field of Instrument Code (Please refer to Appendix B)
- Leading zero is filled in the field of Strike Price (together with the field of Number of Decimal Place(s) for Price Fields in the Message Contents, they present the actual strike price)
- It may not exist in some PRS message structures

Message Contents (variable length)

- Individual data fields in Message Contents may have variable field lengths
- Data fields are separated by backslash ('\') as the field delimiter
- A single zero ('0') is filled for any unused numeric field
- A single blank character is filled for any unused character or alphanumeric field
- Price fields in quotation message may contain ('-') sign for negative price value

4.1 Trade Detail Message

Field group	Description	Length	Reference
SOH	SOH control character	1	Hex 01
Header	Message Category	1	Character
	Message Type	1	Character
	Real-time Indicator	1	Numeric
	Time Stamp	6	Numeric; HHMMSS
STX	STX control character	1	Hex 02
PRS Series ID	Commodity Code	5	Please refer to Appendix A
	Instrument Code	3	Please refer to Appendix B
	Expiry Date	4	Numeric; MMY Y
	Strike Price	7	Numeric; (Note 2)
Contents	Field delimiter	1	“\”
	Number of Decimal Place(s) for Price fields	1	Numeric
	Field delimiter	1	“\”
	Cumulative Volume		Numeric
	Field delimiter	1	“\”
	Total Number of Deal		Numeric
	Field delimiter	1	“\”
	Deal Type		Numeric; (Note 8) Please refer to Appendix C
	Field delimiter	1	“\”
	Last Trade Price		Numeric; (Note 2, 7 & 9)
	Field delimiter	1	“\”
Last Trade Volume		Numeric; (Note 7)	
ETX	ETX control character	1	Hex 03

Note:

- Valid combinations of message category and message type are TT and TV.
- The actual value is determined by applying the number of decimal place(s) for price fields provided.
- TT message type provides information on trades concluded or reported in HKATS. A TT message may also be triggered by cancellation of trades or update on any data fields in Contents.
- TV message type is triggered by the adjustment of Cumulative Volume in the market.
- TV carries the information of Number of Decimal Place(s) for Price fields and Cumulative Volume only in the Contents area.
- The Contents always carries the latest values in the market. HKEx may disseminate the latest values at any time to update the market information.
- The Last Trade price and Last trade volume for some of the deal types are not updated in TT. Please refer to Appendix C for detail.
- In case of trade cancellation resulting in no trades on the series, the value of Deal Type is “1” in the message which updates all transaction related fields, such as Cumulative Volume, Total Number of Deal, Last Trade Price and Last Trade Volume to zero values.
- The price field may contain (-) sign to denote negative price value.
- For a combination trade, TT of deal type “7” will be generated for the combination series as well as its legs. It is important to note that trade price and volume are recorded against the combination series only but not the legs. The cumulative volume of the combination series as well as the legs will be updated as per combination trade.
- Therefore as a result of a combination trade, the TT message for the combination series will show the trade price and volume of the combination trade as the Last Trade Price and Last Trade Volume respectively, while the TT message for each leg will have the previous trade price and volume of that leg in the Last Trade Price and Last Trade Volume fields respectively.

4.2 Trade Statistic Message

Field group	Description	Length	Reference
SOH	SOH control character	1	Hex 01
Header	Message Category	1	Character
	Message Type	1	Character
	Real-time Indicator	1	Numeric
	Time Stamp	6	Numeric; HHMMSS
STX	STX control character	1	Hex 02
PRS Series ID	Commodity Code	5	Please refer to Appendix A
	Instrument Code	3	Please refer to Appendix B
	Expiry Date	4	Numeric; MMY Y
	Strike Price	7	Numeric; (Note 2)
Contents	Field delimiter	1	“\”
	Number of Decimal Place(s) for Price fields	1	Numeric
	Field delimiter	1	“\”
	Open Trade Price		Numeric; (Note 2 & 6)
	Field delimiter	1	“\”
	Highest Trade Price		Numeric; (Note 2 & 6)
	Field delimiter	1	“\”
	Lowest Trade Price		Numeric; (Note 2 & 6)
	Field delimiter	1	“\”
Trade Report Volume		Numeric	
ETX	ETX control character	1	Hex 03

Note:

1. Valid combination of message category and message type is TS.
2. The actual value is determined by applying the number of decimal place(s) of price fields provided.
3. TS message type is triggered by booking of Block Trade or update on any data fields in Contents.
4. “Trade Report Volume” field contains the accumulated volume of contracts as traded by “Trade Report” function in HKATS. “Trade Report” is also called as “Block Trade” in market.
5. The Contents always carries the latest values in the market. HKEx may disseminate the latest values at any time to update the market information.
6. The price field may contain (-) sign denote negative price value.

4.3 Summary Statistics Message

Field group	Description	Length	Reference
SOH	SOH control character	1	HEX 01
Header	Message Category	1	Character
	Message Type	1	Character
	Real-time Indicator	1	Numeric
	Time Stamp	6	Numeric; HHMMSS
STX	STX control character	1	HEX 02
PRS Series ID	Commodity Code	5	Please refer to Appendix A
	Instrument Code	3	Please refer to Appendix B
	Expiry Date	4	Numeric; MMY Y
	Strike Price	7	Numeric; (Note 2)
Contents	Field delimiter	1	"\
	Number of Decimal Place(s) for Price fields	1	Numeric
	Field delimiter	1	"\
	Open Buy Quote		Numeric; (Note 2 & 8)
	Field delimiter	1	"\
	Open Sell Quote		Numeric; (Note 2 & 8)
	Field delimiter	1	"\
	Open Trade Price		Numeric; (Note 2 & 8)
	Field delimiter	1	"\
	Closing Buy Quote		Numeric; (Note 2 & 8)
	Field delimiter	1	"\
	Closing Sell Quote		Numeric; (Note 2 & 8)
	Field delimiter	1	"\
	Settlement Price		Numeric; (Note 2-4)
	Field delimiter	1	"\
	Day Highest Price		Numeric; (Note 2 & 8)
	Field delimiter	1	"\
	Day Lowest Price		Numeric; (Note 2 & 8)
	Field delimiter	1	"\
	Cumulative Volume		Numeric
Field delimiter	1	"\	
Net Open Interest		Numeric	
Field delimiter	1	"\	
Gross Open Interest		Numeric	
ETX	ETX control character	1	HEX 03

Note:

- Valid combinations for message category and message type are SA, SE, SM and SS only.
- The actual value is determined by applying the number of decimal place(s) for price fields provided.
- The Start-of-day Summary Statistics (type code 'S'), which is disseminated before market open, carries the settlement price, net and gross open interest of previous business day. Their values are zeroes for new series except adjusted series. In case of capital adjustment effective on the current day, the settlement price and the open interest information of the previous day will have been transferred to the newly created adjusted series from the original series before market open. There will not be Start-of-day Summary Statistics for the original series as they are no longer tradable.
- The Market Close Summary Statistics for T Session (type code 'M'), which is disseminated after close of the T Session, carries the current day settlement price. The trading price and volume information is for the T Session only.
- The End-of-day Summary Statistics for T Session (type code 'E'), which is disseminated after close of the T Session, carries the current day net and gross open interest. The trading price and volume information is for the T Session only.

6. The End-of-After Hour Session Summary Statistic (type code 'A'), which is disseminate after close of T+1 Session, carries only trading price and volume information, but not settlement price and open interest, for the T+1 Session.
7. Please refer to Section 6.1 in this document for details.
8. The Contents always carries the latest values in the market. HKEx may disseminate the latest values at any time to update the market information.
9. The price field may contain (-) sign to denote negative price value.
(Remarks: This message category is currently not applicable to combination series.)

4.4 Control/Freeform/Alert Message

Field group	Description	Length	Reference
SOH	SOH control character	1	HEX 01
Header	Message Category	1	Character
	Message Type	1	Character
	Real-time Indicator	1	Numeric
	Time Stamp	6	Numeric; HHMMSS
STX	STX control character	1	HEX 02
Contents	Current Message Count	1 – 2	Numeric; Valid range: 1 .. 99; (Note 5) It indicates the current message number out of the “Total number of Messages”
	Field delimiter	1	“\”
	Total Number of Message(s)	1 – 2	Numeric; Valid range: 1 .. 99; (Note 5) It indicates the total number of messages as a group
	Field delimiter	1	“\”
	Message Text	80	Alphanumeric
ETX	ETX control character	1	HEX 03

Note:

- Valid combinations for message category and message type are CE, CF and CS only.
- For message type ‘S’, start of day message (“Start of day”) is stored in the field of Message Text, while end of day message (“End of day”) is stored for message type ‘E’.
- For message type ‘F’, the freeform/alert message is presented in the field of Message Text. **The first message (i.e. the Current Message Count field = 1) is the subject of the freeform/alert message.**
- The “Message Text” field has a fixed length of 80 characters. Delimiter “\” may contain inside the Message Text.
- Current Message Count and Total Number of Message(s) have variable field length. The minimum and maximum field length is 1 and 2 respectively. These fields contain no leading zero or trailing blank and the valid values range from 1 to 99. The field value of Current Message Count must be less than or equal to that of Total Number of Message(s).

4.5 Underlying Instrument Message

Field group	Description	Length	Reference
SOH	SOH control character	1	HEX 01
Header	Message Category	1	Character
	Message Type	1	Character
	Real-time Indicator	1	Numeric
	Time Stamp	6	Numeric; HHMMSS
STX	STX control character	1	HEX 02
Contents	Commodity Code	5	Please refer to Appendix A
	Field delimiter	1	“\”
	Number of Decimal Place(s) for EAS value	1	Numeric
	Field delimiter	1	“\”
	EAS value of Commodity		Numeric; (Note 2)
	Field delimiter	1	“\”
	Number of Decimal Places(s) for Commodity Index value	1	Numeric
	Field delimiter	1	“\”
	Commodity Index value		Numeric
	Field delimiter	1	“\”
	Reserved	1	Blank
ETX	ETX control character	1	HEX 03

Note:

- Valid combinations of message category and message type are UH, UL and UT only.
- The actual value is determined by applying the number of decimal place(s) for EAS value provided.
- UT message carries the latest EAS value for the underlying.
- UH/UL message carries the adjustment of the highest & lowest figures for the commodity Index value. (Commodity index value is not available for Hang Seng Family of Indices)
- These message types are available to equity index (except mini products) and equity products.
- The Contents always carries the latest values in the market. HKEx may disseminate the latest values at any time to update the market information.

4.6 Price Depth Quotation Message (5 levels)

Field group	Description	Length	Reference
SOH	SOH control character	1	HEX 01
Header	Message Category	1	Character
	Message Type	1	Character
	Real-time Indicator	1	Numeric
	Time Stamp	6	Numeric; HHMMSS
STX	STX control character	1	HEX 02
PRX Series ID	Commodity Code	5	Please refer to Appendix A
	Instrument Code	3	Please refer to Appendix B
	Expiry Date	4	Numeric; MMY Y
	Strike Price	7	Numeric; (Note 2)
Contents	Field delimiter	1	“\”
	Number of Decimal Place(s) for Quote fields	1	Numeric
	Field delimiter	1	“\”
	1 st Best Bid/Ask Quote		Numeric; (Note 2 & 3)
	Field delimiter	1	“\”
	1 st Best Demand		Numeric
	Field delimiter	1	“\”
	2 nd Best Bid/Ask Quote		Numeric; (Note 2 & 3)
	Field delimiter	1	“\”
	2 nd Best Demand		Numeric
	Field delimiter	1	“\”
	3 rd Best Bid/Ask Quote		Numeric; (Note 2 & 3)
	Field delimiter	1	“\”
	3 rd Best Demand		Numeric
	Field delimiter	1	“\”
	4 th Best Bid/Ask Quote		Numeric; (Note 2 & 3)
	Field delimiter	1	“\”
	4 th Best Demand		Numeric
Field delimiter	1	“\”	
5 th Best Bid/Ask Quote		Numeric; (Note 2 & 3)	
Field delimiter	1	“\”	
5 th Best Demand		Numeric	
ETX	ETX control character	1	HEX 03

Note:

- Valid combinations of message category and message type are QC and QD only.
- The actual value is determined by applying the number of decimal place(s) for quote fields provided.
- The price field may contain (-) sign to imply as negative price value.
- QC message type is triggered by any best ask price and demand update on 5 levels.
- QD message type is triggered by any best bid price and demand update on 5 levels.
- These message types are only available to information vendors subscribing package with price depth.
- For series with auction order (A.O), when there is auction quotation input into the market, the 1st best bid and 1st best ask quotes will be defined as “9999999”. In HKATS, the auction quotation (i.e. “9999999”) may be updated into 2nd level when the best price is recalculated during auction session. All price levels will be updated immediately in the next second.
- The Contents always carries the latest values in the market. HKEx may disseminate the latest values at any time to update the market information.

4.7 Series Definition Message

Field group	Description	Length	Reference
SOH	SOH control character	1	HEX 01
Header	Message Category	1	Character
	Message Type	1	Character
	Real-time Indicator	1	Numeric
	Time Stamp	6	Numeric; HHMMSS
STX	STX control character	1	HEX 02
PRS Series ID	Commodity Code	5	Please refer to Appendix A
	Instrument Code	3	Please refer to Appendix B
	Expiry Date	4	Numeric; MMY Y
	Strike Price	7	Numeric; (Note 2)
Contents	Field delimiter	1	"\
	Series Name in HKATS	40	Alphanumeric; (Note 7)
	Field delimiter	1	"\
	Number of Decimal Place(s) for Price fields	1	Numeric
	Field delimiter	1	"\
	Market ID		Numeric; Please refer to Appendix D
	Field delimiter	1	"\
	Last Trade Date	8	Numeric; YYYYMMDD
	Field delimiter	1	"\
	Trading Status	1	Numeric; Values(1, 2) (Note 8)
	Field delimiter	1	"\
	Trading Currency	3	Alphanumeric
	Field delimiter	1	"\
	Number of Reference Series	1	Numeric; Values(0, 2 .. 4)
<i>The occurrence of the following field group depends on the value of "Number of Reference Series" (if > 0)</i>			
1 st Reference PRS Series ID (if Number of Reference Series => 1)	Field delimiter	1	"\
	Commodity Code	5	Please refer to Appendix A
	Instrument Code	3	Please refer to Appendix B
	Expiry Date	4	Numeric, MMY Y
	Strike Price	7	Numeric; (Note 2)
:			
:			
4 th Reference PRS Series ID (if Number of Reference Series = 4)	Field delimiter	1	"\
	Commodity Code	5	Please refer to Appendix A
	Instrument Code	3	Please refer to Appendix B
	Expiry Date	4	Numeric, MMY Y
	Strike Price	7	Numeric; (Note 2)
<i>End of variable field group</i>			
ETX	ETX control character	1	HEX 03

Note:

- Valid combinations of message category and message type are DS and DF only.
- The actual value is determined by applying the number of decimal place(s) for price fields provided.

3. The Series Definition (type code 'S'), which is disseminated before market open, carries the details of the tradable series on the business day. PRS may send this kind of message for a newly created series during trading hours to reflect the trading activities in the derivatives market, or PRS may resend this message for an existing series during trading hour for the update of trading status of the series.
4. The Next Day Series Definition (type code 'F'), which is disseminated after market close, carries the definition of tradable standard series on the next business day. All Combo series are excluded.
5. Valid values of Number of Reference Series field are 0, 2 – 4.
For standard HKATS series, the number of reference series is 0.
For standard combo/spread series, the current number of reference series is 2.
6. The reference series are the baits of a combo series.
7. The field "Series Name in HKATS" may contain the same character of Field Delimiter "\". The field is fixed length and padded with trailing space(s) to form a fixed 40-character string.
8. Valid values of Trading Status field are 1 and 2 only.
1 = Suspended
2 = Not Suspended

Example 1) Normal series

```

1DS1080001HSI_ 00401090000000\HSIF9.....\0\34\2009
0129\2\HKD\0-----□
1DF1200001HSI_ 00401090000000\HSIF9.....\0\34\2009
0129\1\HKD\0-----□

```

Example 2) Combo series

```

1DS1080002HSI_ 17101090014600\HSI146A9/142M9.....\0\34\2009
0129\2\HKD\2\HSI_02201090014600\HSI_02301090014200-----□

```

Note: ' ' is a space character in data feed.

4.8 Market/Commodity Status Message

Field group	Description	Length	Reference
SOH	SOH control character	1	HEX 01
Header	Message Category	1	Character
	Message Type	1	Character
	Real-time Indicator	1	Numeric
	Time Stamp	6	Numeric; HHMMSS
STX	STX control character	1	HEX 02
Contents	Market ID / Commodity Code	5	Alphanumeric; Please refer to Appendix D / A
	Field delimiter	1	“\”
	Instrument Code	3	Numeric; Filled with zero if not applicable; Please refer to Appendix B
	Field delimiter	1	“\”
	Status Code		Numeric; Please refer to Appendix E
ETX	ETX control character	1	HEX 03

Note:

1. Valid combinations of message category and message type are MC and MM.
2. Message type ‘C’ declares the status of a commodity code across multiple markets. If instrument code is provided, the status declaration is applied to that particular product only.
3. Message type ‘M’ declares the status of a market/instrument. MM contains “Market ID” and/or “Instrument Code”.
4. The message arrival sequence is totally reflecting the market information in HKATS. MC/MM and trade/quotation messages may be interlaced broadcasting during the change of market state.
5. The Contents always carries the latest values in the market. HKEx may disseminate the latest values at any time to update the market information.

Example of HHI market (instrument level) pre-open session

1MM109150038_ _ _ \004\4—————□

Example of HSI market (market level) open session

1MM109150034_ _ _ \000\3—————□

Example of HKB (commodity level) suspend for trading

1MC1091500HKB_ _ _ \000\90—————□

Note: ‘_’ is a space character in data feed.

4.9 Heartbeat Message

Field group	Description	Length	Reference
SOH	SOH control character	1	HEX 01
Header	Message Category	1	Character
	Message Type	1	Character
	Real-time Indicator	1	Numeric
	Time Stamp	6	Numeric; HHMMSS
STX	STX control character	1	HEX 02
Contents	Reserved (for internal use)	1	Blank
ETX	ETX control character	1	HEX 03

Note:

1. Valid combination of message category and message type is HB.
2. Heartbeat message is sent about every 15 seconds if there is no any real-time message.
3. Real-time indicator is defined as "1".

Sample message:

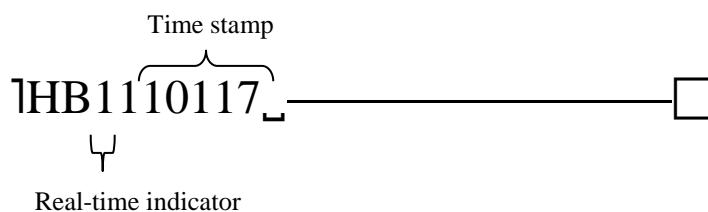

Note: ' ' is a space character in data feed.

Purpose of the Message:

This message indicates the connection is alive between PRS and information vendor's system.

How to use:

This message is broadcast every 15 seconds when the communication line is idle. Information vendor can make use of the heartbeat messages and fail over to the alternate PRS server if **2 or more heartbeat messages are lost.**

5 DATA FIELD CHARACTERISTICS

5.1 Message Category/Code

Message Category	Message Type	Description
T	T	Trade Detail
T	V	Trade Volume Adjustment
T	S	Trade Statistic
Q	C	Ask (Sell) Price Quotation with 5 levels
Q	D	Bid (Buy) Price Quotation with 5 levels
Q	E	Calculated Opening Price (COP)
C	S	Start of Day Message
C	E	End of Day Message
C	F	Control/Freeform/Alert Message
S	S	Start of Day Summary Statistics
S	M	HSI Futures Settlement Price Summary Statistics
		Market Close Summary Statistics
S	E	End of Day Summary Statistics
S	A	End of After-Hour Session Summary Statistics
U	T	EAS and/or Cash of Underlying
U	H	Underlying High Price Correction
U	L	Underlying Low Price Correction
H	B	Heartbeat
D	S	Series Definition
D	F	Next Day Series Definition
M	C	Commodity Status
M	M	Market Status

5.2 Real-time Indicator

This indicator shows whether the downloaded PRS message is real-time data. A value of '1' means it is a real-time message, while '0' for snapshot or market data retransmission.

5.3 Time Stamp

This time stamp field indicates the transmission time in HHMMSS format where HH=hour, MM=minutes and SS=second.

5.4 Snapshot Image for Recovery

Once an information vendor connects to PRS, snapshot image is automatically downloaded at a predefined transmission rate and has a lower sending priority than a real time message.

Example 1:

```

1QC0115834HSI_02209030013400\0\2080\125\2082\39\2085\15\2087\5\2091\1
_____□
1QC0115834HSI_02309030013600\0\2105\65\2118\9\2122\15\2125\5\0\0
_____□
1QC0115834HSI_02309030013800\0\2550\1\2580\1\0\0\0\0\0\0_____□
1QC0115834HSI_02209030014000\0\2850\1\0\0\0\0\0\0\0_____□
1QC1115908HSI_02309030013600\0\2104\5\2105\85\2118\10\2122\6\2125\1
_____□
1QC0115834HSI_02209030014200\0\3180\1\0\0\0\0\0\0\0_____□
1QC0115834HSI_00409030000000\0\3600\1\0\0\0\0\0\0\0_____□

```

Example 2:

```

1UT1120032HSI_0\13259\0\0_____□
1UT0115945HKB_2\7668\0\0_____□
1UT0115946HSI_0\13288\0\0_____□

```

}

Time of message would be earlier than the last image if there is no update.

Note: ‘_’ is a space character in data feed.

Purpose of the function:

Information vendors receive snapshot image automatically after established a PRS connection. Only the recent snapshot image is downloaded. Information vendors are required to sort the messages according to their associated timestamp for the latest market information.

How to use:

Information vendors receive the latest snapshot image of the INSTRUMENT after established a connection to PRS. To minimize the delay of delivering real time message, PRS downloads snapshot image at a predefined rate with priority lower than the real time message.

As demonstrated in Example 1, during the delivery of snapshot messages, if there is an update of a particular series, real time message would be sent at once.

Also demonstrated in Example 2, real time message is sent during the download of snapshot image. Information vendors should compare the timestamp in the message with the last update of the same series. If the timestamp on snapshot message is earlier than that of the real time message, information vendors should ignore the snapshot image.

Scope of message recovery:

- For price depth information vendors, “DS”/“DF” (by default; refer Appendix G) followed by “TS”, “TV”, “TT”, “QC” and “QD” would be delivered as snapshot messages once a connection is established.
- To minimize the impact on real-time data from PRS system, snapshot image would be disseminated at a predefined rate per second.

6 MARKET MESSAGE SCHEDULE

6.1 Summary Statistics Broadcasting Time

Commodity code / Product type	Description and Message type				
	Start-of-day Summary Statistics SS	Settlement Price of HSI Futures Summary Statistics SM	Market Close Summary Statistics SM	End-of-day Summary Statistics SE	End-of-After Hour Session Summary Statistics SA
HSI Futures	7:45	17:30 [#]	18:30 – 20:30 [*]	20:30 – 22:00 [^]	23:15 – 23:30[%] <u>23:45 – 00:30[%]</u>
EF3		N/A			
HSI Options, MHI, HHI, MCH					
HB1, HB3					
GLD					
LSF					
LSO		19:00 – 20:30 ^{&}			

	Message Type	Statistic fields	Market
	SS	[Gross & Net OI before market open] [Settlement before market open]	All markets
#	SM (Settlement price)	[Open – Buy/Sell/Trade] [Close – Buy/Sell] [Day High/Low] [Settlement] [Cumulative Volume] [Gross & Net OI before market open]	HSI Futures only
*	SM (Market close)	[Open – Buy/Sell/Trade] [Close – Buy/Sell] [Day High/Low] [Settlement] [Cumulative Volume] [Gross & Net OI before market open]	All markets (except LSO)
&	SM (Market close)	[Open – Buy/Sell/Trade] [Close – Buy/Sell] [Day High/Low] [Settlement] [Cumulative Volume] [Gross & Net OI]	LSO only
^	SE	[Open – Buy/Sell/Trade] [Close – Buy/Sell] [Day High/Low] [Settlement] [Cumulative Volume] [Gross & Net OI]	All markets
%	SA	[Open – Buy/Sell/Trade] [Close – Buy/Sell] [Day High/Low] [Cumulative Volume]	All AHFT markets

Remarks:

N/A - Not Applicable

Note:

- On half-day trading day,
 # * & : The broadcasting time of SM (HSI Futures settlement price and market close) messages would be shifted 3 hours (approx.) earlier than specified in the timetable.
 ^ % : The broadcasting time of SE/SA messages would be earlier than that specified in the above table.
- The actual broadcasting time may vary due to operation issue.

7 MARKET DATA RETRANSMISSION

7.1 *Data Retransmission Function*

DESCRIPTION

PRS Data Retransmission function provides an application interface for information vendors to retrieve missing market data from PRS for the purpose of data recovery. PRS listens to any request submitted by information vendor applications for downloading market data from the first lost message detected just before disconnection (for recoverable gaps) or from a complete database download (for gaps too large to recover). When an information vendor connection is accepted, PRS will download the requested market data according to the requester's parameters. Upon completion of the download process, PRS would terminate the information vendor connection immediately.

The data format is conformed to **Section 4** of this document.

NETWORK INFRASTRUCTURE

The existing network infrastructure with all information vendors is shared for data retransmission.

A **new host IP address and a new port number** are provided to information vendors for submitting data download request. Once the requester's status and input parameters are validated, the intra-day data will be disseminated to the information vendor according to its request.

For network infrastructure information, please refer to **Section 3.3** in this document.

PERFORMANCE

Blocked socket mode is used between PRS Data Retransmission Server and Information Vendor application to ensure the reliability of data transfer. If the data download channel is suddenly disconnected, information vendor is required to re-establish the connection with PRS, and downloads data from the last received message.

RECOVERY MECHANISM

PRS Data Retransmission Server is running in TMH site (HKFE Secondary Data Centre) as active mode and running in the CES site (HKFE Primary Data Centre) as backup mode. In case of failure, the backup PRS Data Retransmission Server will be enabled in the CES site. Information vendors, whose have subscribed the PRS Data Retransmission function, would be notified to change the connecting IP address for data download.

PROCESS FLOW DIAGRAM

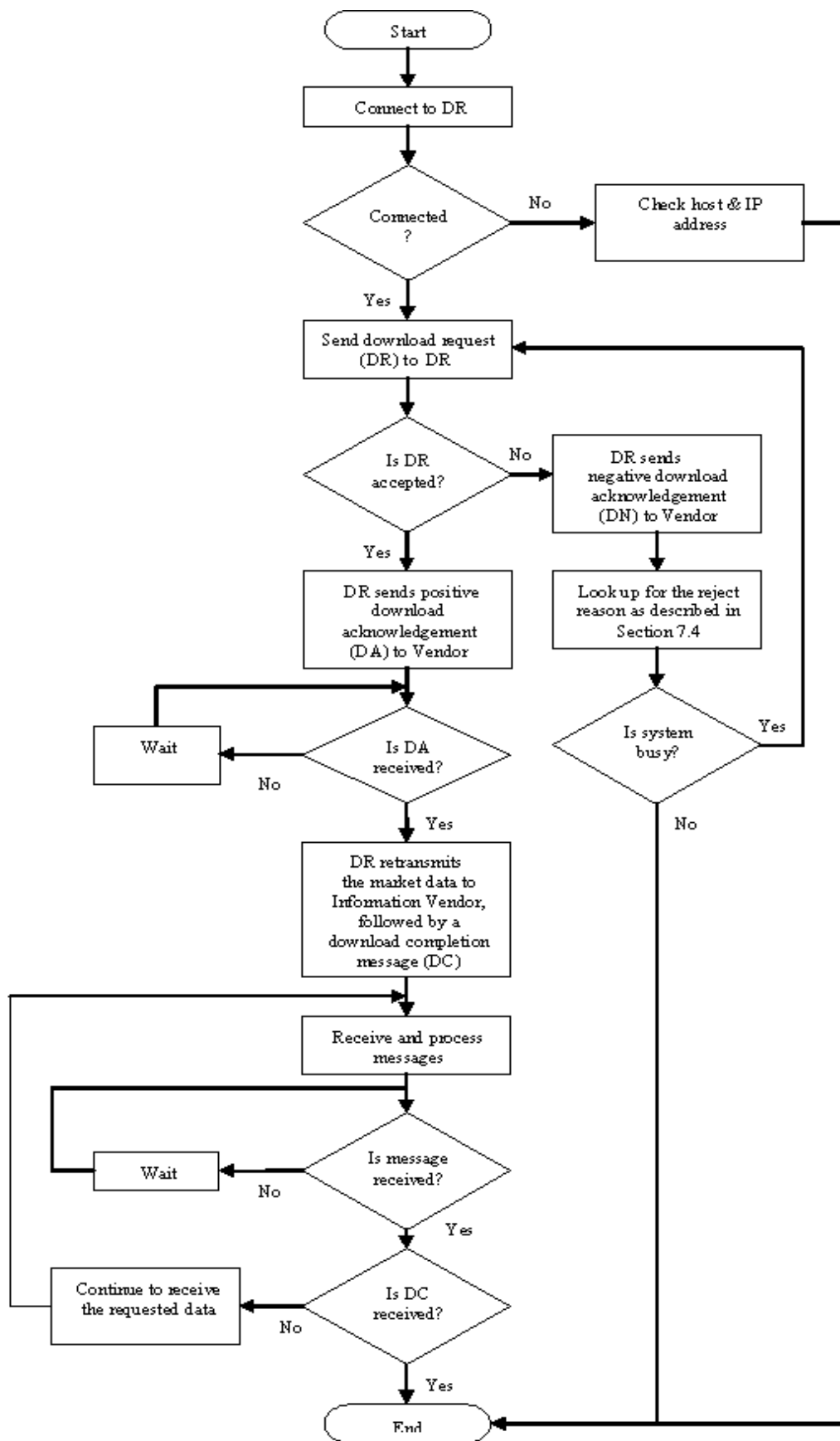

7.2 Data Recovery Period

The PRS Data Retransmission Server provides a channel for information vendors to request retransmitting missing market data from the PRS in current day for data recovery purpose. The sequence of market messages disseminated from PRS Data Retransmission Server may not be in the exact sequence as received through the real time data channel. The purpose of the data retransmission is mainly for the recovery of missing price movement during a specific period of time or for the recovery of whole day data after day end.

7.3 Supported Message Type

All the existing message types specified in Section 5.1 are supported. If there is new message type to be inserted, it will be included in the PRS automatically.

Note: Retransmission does not contain “Heartbeat message type”.

7.4 Making a Download Request

The Information Vendor application sends a download request (DR) to PRS Data Retransmission Server with the following parameters: (Please note that the system allows the retrieval of current day data only.)

Field	Mandatory	Length	Data Type/ Format	Example
Start Time	Yes	6	Numeric, HHMMSS	102000
End Time	No	6	Numeric, HHMMSS	105530
Reserved	-	8	00000000	00000000
Transfer Rate	No	3	Numeric, N(3)	100

- End Time

If the End Time is not specified, it will be set to the time when the download request is submitted by the Information Vendor. If an invalid request is received from the information vendor, an error code will be returned.

- Transfer Rate

Transfer rate defines the number of messages to be downloaded from the server per second. If the transfer rate is not specified or is over the pre-defined maximum transfer rate in the system, the maximum system transfer rate will be used.

The following is an example of a download request (DR):

DR	102000	105530	00000000	100	ϵ_{r_x}
----	--------	--------	----------	-----	------------------

Note: All fields in a download request are fixed length and padded with leading zero. Optional fields are filled with zeros if they are not used.

Upon receipt of download request from information vendor, PRS/DR responses with either positive download acknowledge (DA) or negative download acknowledge (DN) with the following fields:

- Download request respond time (e.g. ‘123500’)
- Start time (e.g. ‘102000’)
- End time (e.g. ‘105530’)
- Today’s date (e.g. ‘20030616’)
- Transfer rate (e.g. ‘100’. Show ‘999’ when system default is used.)
- 2-digit error code [for DN only] (e.g. ‘03’)

The following is an example of a positive download acknowledge (DA) message:

ζ_{0g}	DA	0	123500	ζ_{ix}	102000	105530	20030616	100	ζ_{ix}	ζ_g	ζ_f
--------------	----	---	--------	--------------	--------	--------	----------	-----	--------------	-----------	-----------

The following is an example of a negative download acknowledge (DN) with error code 03:

ζ_{0g}	DN	0	123500	ζ_{ix}	102000	105530	20030616	100	03	ζ_{ix}	ζ_g	ζ_f
--------------	----	---	--------	--------------	--------	--------	----------	-----	----	--------------	-----------	-----------

The following are possible error codes:

Error Code	Explanation
01	Unauthorized access of an information vendor. The IP address of the information vendor is not authorized.
02	PRS/DR is busy since the maximum number of concurrent connection is encountered. When PRS/DR reaches this limit, all new coming information vendor connections are held for a configurable timer and then disconnected with this error code.
03	Information vendor specific daily download limit is exceeded. For example, if an information vendor is allowed to connect for 5 times daily (only those with successful download counts), this error code will be issued if the Information Vendor attempts to connect at 6 th time, with regardless of which instance (primary, or secondary, etc) of PRS/DR the information vendor attempts to connect to.
04	Information vendor specific maximum concurrent connection limit is exceeded. For example, if an information vendor is allowed for 2 concurrent connections, this error code will be issued if the information vendor attempts to make the 3 rd concurrent connection.
10	Start-time specified in the download request is invalid
11	End-time specified in the download request is invalid
13	Transfer rate specified in the download request is invalid
14	Start time later than End-time, download reject
17	End-time beyond the request time
20	Invalid message type
21	Timeout before reading download request from information vendor
91	Unable to determine record length from market data file
92	Unable to open market data file
93	Unable to read a record from market data file
94	Unable to create thread to handle new information vendor connection

Note:

For some errors due to system constraints or limitations, the negative download acknowledges (DN) may have the following values:

- Start time is blank
- End time is equal to the download request respond time
- Transfer rate is reset to the default system setting

If a negative download acknowledge is sent to information vendor, the socket is then closed.

If a positive download acknowledge is sent to information vendor, retransmission of the market data would be downloaded in the same format as in real-time market data. The real-time indicator is set to '0'.

After the requested market data is retransmitted to information vendor, a download completion (DC) message would be sent to information vendor before PRS/DR closes the socket. The download completion message contains (with reference to STX) the following information for reconciliation:

- the first two fields (i.e. Start-time, End-Time) are extracted directly from download request

- the third field indicates the date of the download
- the fourth field shows the transfer rate
- the fifth field specifies the downloaded line count

The following is an example of a download completion (DC) message:

ζ_{dc}	DC	0	123500	ζ_{tr}	102000	105530	20030616	100	000012545	ζ_{tr}	ζ_r	ζ_f
--------------	----	---	--------	--------------	--------	--------	----------	-----	-----------	--------------	-----------	-----------

7.5 *Retransmission Limitation*

CONCURRENT CONNECTIONS

Each information vendor can only establish ONE connection through one set of leased lines at any one time. Excessive connections would be rejected by the PRS Data Retransmission Server.

ATTEMPT PER BUSINESS DAY

Each information vendor is limited to connect the PRS Data Retransmission server for a maximum of 10 times a day. Excessive attempts would be rejected.

Note:

If an information vendor connection is accepted by the PRS Data Retransmission server, information vendor should submit a download request within the next 30 seconds. Otherwise, a DN with error code '21' would be sent to the information vendor and the connection would be terminated by the server automatically. However, this connection attempt is not being counted.

AUTHORIZED CONNECTION

In the same manner of receiving real time data from PRS, each information vendor should be assigned an authorized IP address to connect the PRS retransmission Server. All connections other than the assigned IP address will be rejected.

BANDWIDTH LIMITATION

Since information vendors are using the same network / server to receive both real time data and data recovery from PRS, they must try to prevent this activity during the trading hour. Real time data disseminated from PRS is sending in blocking mode, and data lost may occur if the bandwidth is over consumed by retrieving a large volume of data during a volatile market.

AVAILABLE BUSINESS DAY

Only current business day data is available for download from the PRS Data Retransmission server. All connections would be terminated after disseminated the End-of-day control message ('CE') through the real-time data channel. The historical data will then be removed after the execution of PRS end-of-day process.

APPENDIX A: LIST OF COMMODITY CODE

Exchange Fund Note Futures:

<u>Code</u>	<u>Description</u>
EF3	Three-Year Exchange Fund Note Futures

Index Futures and Options:

<u>Code</u>	<u>Description</u>
HSI	Hang Seng Index Futures / Options
MHI	Mini Hang Seng Index Futures / Options
HHI	H-shares Index Futures / Options (underlying index: Hang Seng China Enterprises Index)
MCH	Mini H-shares Index Futures
XHS	Flexible Hang Seng Index Options
XHH	Flexible H-shares Index Options
DHS	HSI Dividend Point Index Futures
DHH	HSCEI Dividend Point Index Futures
VHS	HSI Volatility Index Futures
BOV	BRICS BOVESPA Index Futures
BSE	SENSEX Index Futures
SAF	BRICS FTSE/JSE TOP 40 Index Futures
MCX	BRICS MICEX Index Futures
CHH	<u>CESC 120 Index Futures</u>

Hong Kong Interbank Offered Rate (HIBOR) Futures:

<u>Code</u>	<u>Description</u>
HB1	One-Month Hong Kong Interbank Offered Rate Futures
HB3	Three-Month Hong Kong Interbank Offered Rate Futures

Hong Kong Interbank Offered Rate (HIBOR) Contracts:

<u>Code</u>	<u>Description</u>
H1S	1-Month HIBOR Strip Contracts
H3S	3-Month HIBOR Strip Contracts

Note:

- For the composition of HIBOR Strips, please refer to HKEx website under the [HIBOR Futures Product Descriptions](#) of Derivatives Market in the Product Section.

Commodity Futures:

<u>Code</u>	<u>Description</u>
GLD	Gold Futures

Renminbi Currency Futures:

<u>Code</u>	<u>Description</u>
CUS	The US Dollar vs Renminbi (Hong Kong) Futures

Local Stock Futures (LSF) & Options (LSO):

Please refer to the [List of Stock Futures](#) and the [List of Stock Option Classes](#) provided on the HKEx website under the Trading Information of Derivatives Market in the Product Section.

Note:

- HKEx notice will be sent out for any updates on the List of Stock Futures and the List of Stock Option Classes.

APPENDIX B: LIST OF INSTRUMENT CODE

<u>Instrument Code</u>	<u>Description</u>
004	Futures
006	Call (American style)
007	Put (American style)
022	Call (European style)
023	Put (European style)
119	Time Spread (level=1)
120	Time Spread (level=2)
121	Time Spread (level=3)
122	Time Spread (level=4)
149	Time Spread (level=5)
150	Time Spread (level=6)
151	Time Spread (level=7)
152	Time Spread (level=8)
165	Time Spread (level=9)
170	Options Straddle
171	Options Strangle
172	Standard Combination series for Stock Options Market (SOM) – Synthetic Futures
255	Payment Currency

Note:

Instrument codes 004, 006, 007, 022 and 023 are for normal series whereas the remaining are for combo series.

APPENDIX C: LIST OF DEAL TYPE

<u>Deal Type</u>	<u>Description</u>	<u>Last traded price & volume</u>
1	Matched by system, automatically.	Current trade
2	Matched by system, manually.	Current trade
3	Matched outside exchange, different brokers.	Previous trade
4	Matched outside exchange, different brokers, reg. by exchange.	Previous trade
5	Matched outside exchange, one broker.	Previous trade
6	Matched outside exchange, one broker, reg. by exchange.	Previous trade
7	Combination order matched against another combination order when matched by the Exchange, electronically.	Combination series: Current trade Legs of Combination series: Previous trade
20	Deal made at the end of an auction.	Current trade
32	Trade from Bulletin Board.	Previous trade
33	Trade from Bulletin Board, standard combo.	Previous trade
34	Trade from Bulletin Board, non-standard combo.	Previous trade
35	Trade from Bulletin Board, non-standard combo.	Previous trade

Note:

The Last Trade Price and Last Trade Volume for some of the deal types are not updated.

APPENDIX D: LIST OF MARKET ID

<u>Market ID</u>	<u>Description</u>
<u>1</u>	<u>CESC Index Futures / Options</u>
2	Stock Futures
3	Three-Year Exchange Fund Note Futures
8	Gold Futures
16	Mini Hang Seng Index Futures / Options
20	Stock Options
24	HIBOR
27	HSI Dividend Point Index Futures HSCEI Dividend Point Index Futures
34	Hang Seng Index Futures / Options
35	Flexible Hang Seng Index Options
37	Flexible H-shares Index Options
38	H-shares Index Futures / Options
51	HSI Volatility Index Futures
70	Renminbi Currency Futures
93	BRICS BOVESPA Index Futures
96	SENSEX Index Futures
99	BRICS FTSE/JSE TOP 40 Index Futures
102	BRICS MICEX Index Futures

APPENDIX E: LIST OF STATUS CODE

<u>Status Code</u>	<u>Symbol</u>	<u>Description</u>	<u>Applicability</u>	<u>Session</u>
1	OPENALLOC	OPEN ALLOCATION SESSION	Markets with Pre-market Opening Period	Regular
2	CLOSE	MARKET CLOSED	Markets not tradable in T+1 Session	Regular
3	OPEN	MARKET OPEN	All markets	Regular
4	PREOPEN	PREOPEN SESSION	Markets with Pre-market Opening Period	Regular
5	PREOPENALLOC	PREOPEN ALLOCATION SESSION	Markets with Pre-market Opening Period	Regular
6	PAUSE	MARKET PAUSE	All markets	Regular
7	PRE_MKT_ACT	PRE-MARKET ACTIVITIES	Markets without Pre-market Opening Period	Regular
8	CL_START	CLEARING SESSION START	Markets tradable in T+1 Session	All
9	CL_CLOSE	CLEARING SESSION CLOSED	All markets	All
10	AHT_CLOSE	AHFT MARKET CLOSED	Markets tradable in T+1 Session	AHFT
11	AHT_CLR_INFO	AHFT RESET PRICE INFORMATION	Markets tradable in T+1 Session	AHFT
12	AHT_INACT_T_ORDER	AHFT INACTIVE NON T+1 ORDER	Markets tradable in T+1 Session	AHFT
13	AHT_NEXT_DAY	AHFT RESET PRICE INFORMATION FOR NEXT BUSINESS DAY	Markets tradable in T+1 Session	AHFT
14	AHT_OPEN	AHFT MARKET OPEN	Markets tradable in T+1 Session	AHFT
15	AHT_OPEN_PL	AHFT MARKET OPEN	Markets tradable in T+1 Session with price limit control enabled	AHFT
16	AHT_PRE_MKT_ACT	AHFT PRE-MARKET ACTIVITIES	Markets tradable in T+1 Session	AHFT
17	OPEN_PL	MARKET OPEN	Markets enabled with price limit control	Regular
18	CLOSE_TODAY	MARKET CLOSED FOR TODAY TRADING	Markets tradable in T+1 Session	AHFT
19	OPEN_DPL	MARKET OPEN	Markets enabled with dynamic price banding mechanism	All
90		COMMODITY SUSPENDED		All
91		COMMODITY RESUME TRADING		All

APPENDIX F: REMARKS ON TRADE MESSAGE

Definition of TT message type

TT message is defined as the trade information provided from HKATS. TT message contains the traded volume, last trade price and the cumulative volume for series. For pure display purpose, it would synchronize with the values display in HKATS (trade information) window.

Trading in HKATS

After a deal is matched in HKATS, PRS would provide a TT message for updates. The latest cumulative volume is accumulated from previous cumulative volume and current trade volume of the series. The trade price and trade volume are also provided in the latest TT message.

Combination trade

In combo trade, apart from the broadcast of trade messages for individual reference series, PRS also disseminates a trade message (TT) with deal type "7" for the combination series. The trade message of combination series carries the current traded price and volume. Moreover, when condition of Open / Highest / Lowest trade price of the combination series is/are met, PRS disseminates a trade statistic message (TS) message accordingly.

Cancelled trade and Rectified trade in DCASS

Cancelled trade performed during trading hour would cause the cumulative volume decrease from the previous value. A rectified trade would contain the broadcast of a cancelled trade and a new trade. The last trade price, trade volume and cumulative volume would be updated after a cancelled trade.

Example:

Message	Series	Price	Volume	Cumulative Volume	
TT	HSIZ4	12300	11	17745	←Normal trade
TT	HSIZ4	12400	10	17755	←Normal trade
TT	HSIZ4	12200	11	17766	←Normal trade
TT	HSIZ4	12200	11	17755	← Cancelled trade
TT	HSIZ4	12300	2	17757	← Rectified trade

Question & Answer

- Question:** In the cancel trade activity, what will be the trade price and trade volume for the extra TT message?

Answer: The broadcast would contain the latest trade price, **the latest trade volume** and the new cumulative volume in TT message.
- Question:** Will the corresponding TV (Trade Volume Correction) message be sent after Trade Cancellation?

Answer: After market close for the morning session or for the day, market operation would send a TV message to update the cumulative volume. During trading hour, TV would not be sent by market operation.
- Question:** We have found that the sum of volume for all TT does not equal to the Cumulative Volume, our clients may ask whether the total number of ticks is complete or not.

Answer: Please note that TT message is used to provide the latest image of trade information in HKATS. Summation of trade volume in TT messages does not always come up with the same figure as the latest cumulative volume since the last trade volume of some deal types are not provided in TT message (Appendix C). Vendors are recommended to use the Cumulative Volume provided for market total.
- Question:** There is a message TV (Estimated contracts traded correction) with zero price but with cumulative volume increases. How can the price be determined for these transactions?

Answer: Cancel trade and Rectify trade would not trigger a TV message.

TV message is used to correct the cumulative volume when HKFE Market Operation considers that there is a need to correct the cumulative volume in market (usually end of day adjustment).

5) **Question:** Does PRS disseminate traded price and volume for combination series?

Answer: Yes, PRS disseminates TT message (deal type “7”) not only for reference series, but also for the combination series. The trade message of combination series carries the current traded price and volume.

APPENDIX G: RECOVERY OPTION OF SERIES DEFINITION MESSAGE

Description

Series Definition message ('DS') carrying the definition of all series in HKATS is disseminated at the start of a business day at around 7:30am. If information vendor connects after "DS" is disseminated, "DS" message will still be sent to vendor's connection as default before other message types. There is an option flag for information vendor to choose skipping the download of "DS" message during connection failover activities. Information vendor can instruct PRS to skip the dissemination of "DS" message, and proceed to receive snapshot and real-time market messages immediately after reconnection.

Similarly, PRS disseminates the Next Day Series Definition message ("DF") after market close at around 8pm. The same option flag mentioned earlier also applies to the choice of downloading "DF" message.

Performance

When an information vendor submits a valid option flag within 3 seconds after connected to PRS, PRS would skip sending series definition message to the connected channel and disseminate snapshot and real-time data immediately.

"DS" message carries the definition and mapping of series information traded in HKATS on the current business day. Therefore, most of the vendor application system may handle 'DS' message for a fresh start up. Under failover scenario, information vendor may not require "DS" when re-establishing connection to PRS. For fast recovery after disconnection, vendor application is suggested to have an intelligent to determine the necessity of downloading "DS" message.

The length of 'DS' message is around 120 bytes. PRS can disseminate in full strength around 2000 series per second on 5 Mbps bandwidth. The overall time finish the dissemination of "DS" depends on vendor's processing speed and the volume of series in the market.

For next day effective series (except combo series), PRS disseminates such information through "DF" message after market close. Since it does not affect the transmission of real-time market data, performance concern during the recovery of series definition message will not be discussed here.

Download

PRS would broadcast the first round of series definition message to all connected information vendors before market open. The option flag has no effect if information vendor connects to PRS before the first round of "DS" is being broadcasted. It also has no effect to the download of "DF" before its scheduled broadcast timetable.

Information vendor, who is late connecting to PRS or intends to skip the series definition message, needs to provide an input parameter when establishing a new PRS connection. The format of input string contains 3 characters:

Field group	Description	Length	Reference
SOH	SOH control character	1	HEX 01
Option Flag	"1" - <i>Skip the downloading of series definition messages</i> Others - Ignore	1	Alphanumeric
ETX	ETX control character	1	HEX 03

PRS would validate the string and option flag from information vendor to ensure that the request is valid. If the syntax matches with the above specification, PRS will skip the dissemination of series definition message immediately.

Missing or invalid syntax will be ignored and series definition messages (if present) will be sent as default.

Operation Flow Diagram

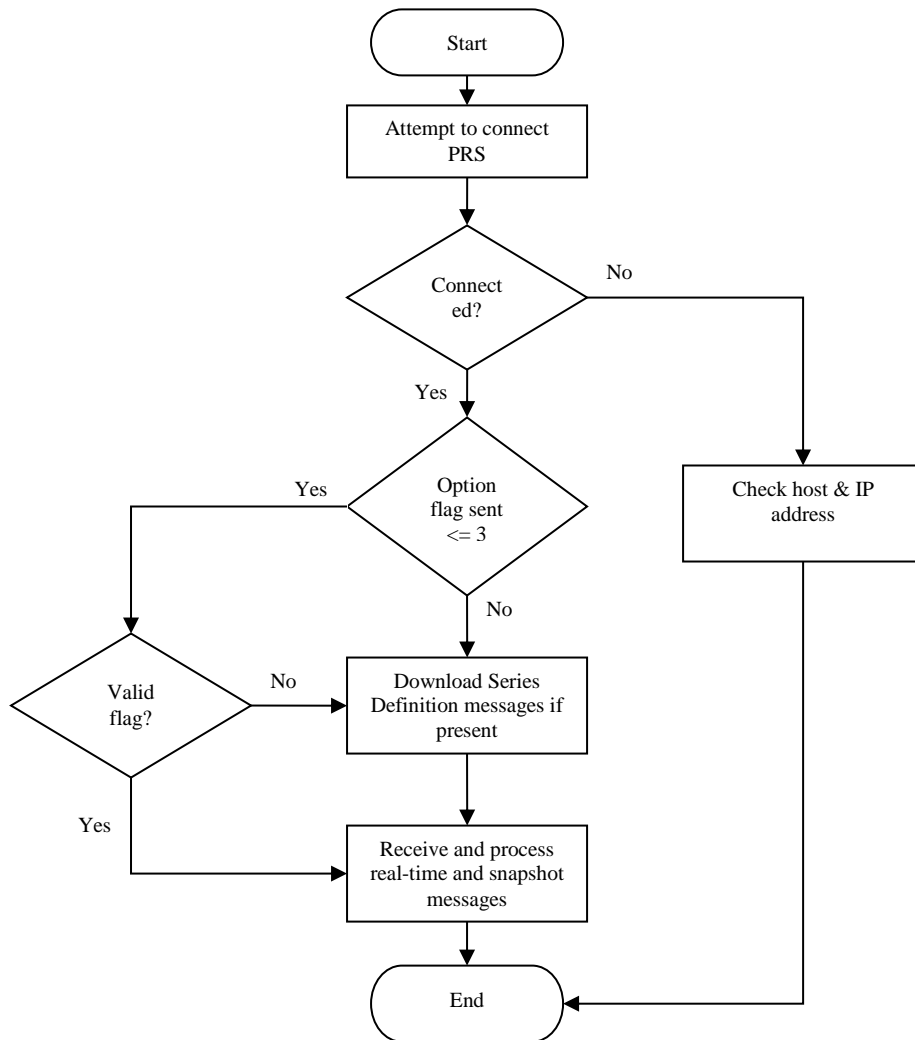

Download Request Limitation

The limitation of the series definition download attempt is controlled by the daily connection constraint as described in **Section 3.3.3 Connection Constraint**.